

## OPERATION & INSTRUCTION MANUAL

### iTouch GS08M(9kW & 18kW)

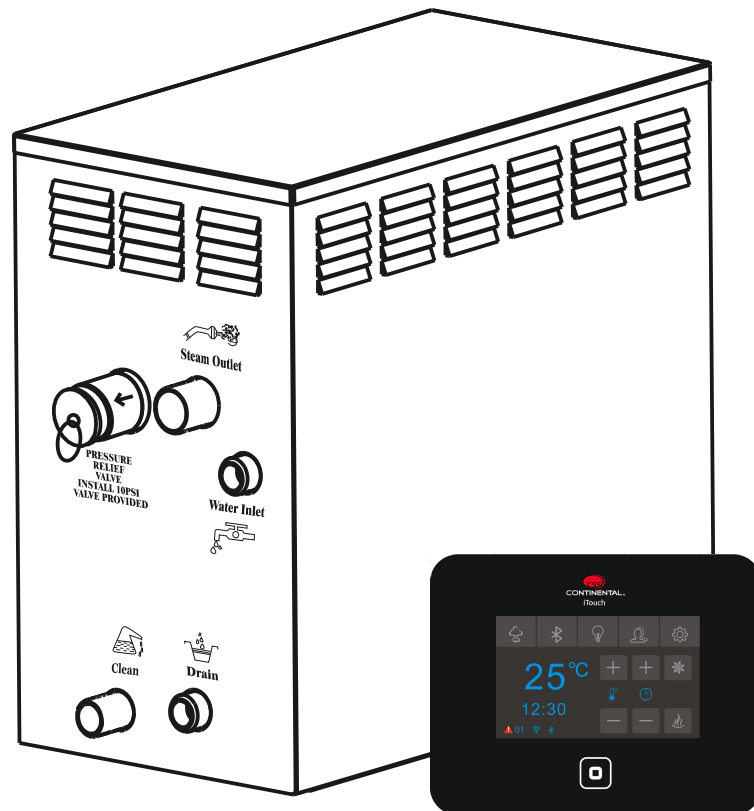

**Index**

<b>Prologue</b> -----	<b>1</b>
<b>Users instruction</b> -----	<b>1</b>
<b>Choosing a suitable location</b> -----	<b>1</b>
<b>Installation drawing of the steam generator</b> -----	<b>2</b>
<b>Installation of pipeline</b> -----	<b>3-4</b>
<b>Blueprint for the steam generator</b> -----	<b>5</b>
<b>Electrical requirements</b> -----	<b>6</b>
<b>Installation of the top light</b> -----	<b>7</b>
<b>Choose your type of machine</b> -----	<b>8</b>
<b>Maintenance of the steam generator</b> -----	<b>8</b>
<b>Configuration of steam generator</b> -----	<b>9</b>
<b>Control Panel Layout and Interface</b> -----	<b>10</b>
<b>Control Panel Installation</b> -----	<b>11</b>
<b>Control Panel Dimensions</b> -----	<b>12</b>
<b>Operation Instructions</b> -----	<b>13-18</b>
<b>Trouble shooting</b> -----	<b>19</b>
<b>Trouble shooting methods</b> -----	<b>20</b>
<b>Ampere Meter</b> -----	<b>21</b>
<b>Technical parameter</b> -----	<b>22</b>
<b>Figure(Heating element and Power line assemble illustration)</b> -----	<b>23-25</b>

## Prologue

Welcome to the iTouch GS08M series steam generator, this series contains a steam generator and a controller. You can adjust the temperature of the steam room and set the working time of the steam generator as you wish. The system contains an overheat/dry-burnt protection system and a security valve in order to prevent overheating to ensure that the steam generator is working at a regular air pressure. It is the best in its class of steam room equipment for the modern family, hotel, spa and health club. You will be satisfied with the noticeable effects on pain relief, weight control, skin stimulation and stress reduction due to an increased blood circulation from the use of the steam room. The iTouch GS08M series comes in 2 models with an output power of 9kw & 18kW.

## Users instruction



**Caution:** *Please note that we cannot be held responsible for any malfunction or damage as a result of an installation that does not comply with the instruction manual.*

1. Make sure the model and the accessories are correct, include the voltage input.
2. Make sure the steam power is matched with the steam room' dimensions.  
Pay close attention to the steam room's cubage and construction. If you have any questions, please refer to the Page 8 about the dimension selection.
3. Make sure to read this manual carefully for secure and effective use.
4. This product must be used indoor.

## Choosing a suitable location

Recommendations for correct installation.

1. The distance to the steam room should be less than 6m, the standard pipe which links the controller and the steam generator should be 6.5m.
2. The steam generator should not be installed in the steam room.
3. Do not install it in the frigid loft or any place where the water can freeze.
4. Do not install the steam generator in close proximity to hazardous substances.
5. Installed in a dry place with good ventilation.
6. If the steam generator is installed in an inaccessible place ensure that both the electrical power and water supply can be isolated in an emergency.

7. The steam generator has a hanging groove for mounting on the wall. Make sure the steam generator is sturdy and installed level side to side and front to back, and installed so that the arrow on the case is pointing up.
8. The steam generator requires at least 300mm of space around both the sides and the top of the steam generator.
9. The location where the machine is installed must be convenient for the disassembly of the machine.
10. The installation place must have a drain for water that is drained from the tank.
11. The steam tube, safety valve, drain valve, water tube & steam outlet are still very hot after the steam generator has been switched off for some time. Please take measures, for example using heat insulation tube to prevent damage to the hot tube and keep the outlet away from the people.
12. The controller can be installed in the steam room, please refer page 11 for the controller's Installation instructions.

**Attention:** *The steam generator (including the controller) comply with the CE and UL certificate, and are adaptive in the moisture environment.*

### Installation drawing of the steam generator

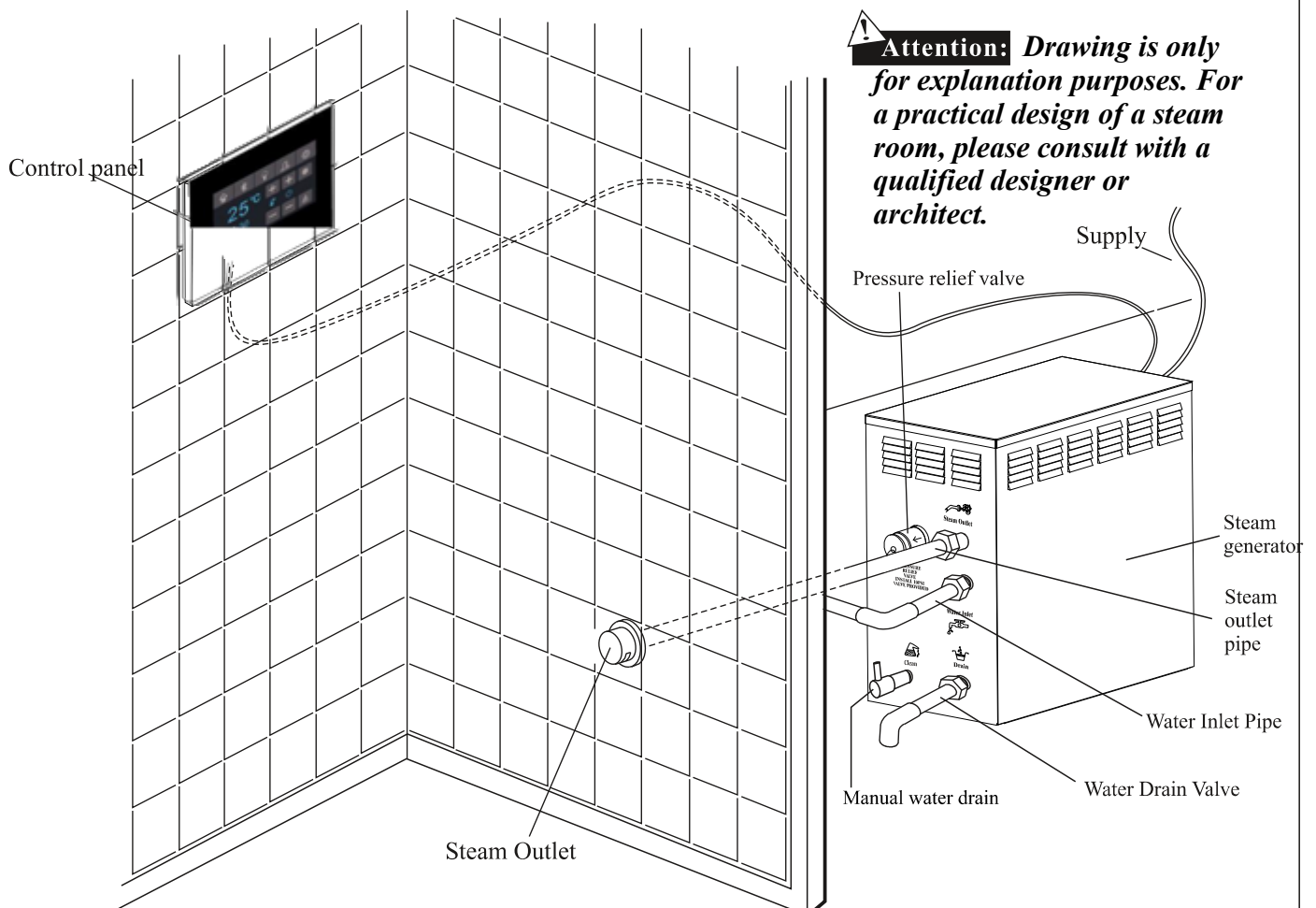

## Installation of pipeline

 **Warning:** *The installation of all the pipes should be done by qualified plumbers with corresponding operation certificate in accordance with national requirements:*

1. Use joints when connecting pipes.
2. Only use copper pipes.
3. Do not use black and galvanized or PVC pipes.

### Water supply pipe

1. We recommend a hot water supply with a temperature no more than 70°C.
2. Install a tap on the water supply pipe. The tap should be installed in a place where it is easily operated in an emergency.
3. Flush the water supply pipe completely before connecting the water pipe to the steam generator.
4. We recommend the installation of anti-furring (Descaling) equipment on the water supply pipe.
5. Water pressure should not exceed 5bar.

### Steam pipe (9kw & above: 3/4")

1. Do not install any valves on the steam pipes. The steam can never be obstructed.
2. Install a copper steam pipe (9kw & above:3/4") as connector between the steam outlet and the steam nozzle.
3. The heat insulation material used to insulate the steam pipe should be resistant to temperature as high as 120°C or higher.
4. The horizontal parts of the steam pipe should always be installed declining towards the steam outlet. Avoid sagging or bends in the pipe, so as to prevent any cool water from settling in the curve of the steam pipe.
5. The shorter the steam pipe, the better. Try to decrease the number of elbows and avoid abrupt turns.

 **Attention:** *Do not create a trap into which condensation can gather and cause a blockage. i.e. the pipe must not go down and then up.*

### Steam nozzle (9kw & above: 3/4")

 **Attention:** *Since the steam nozzle and steam outlet are very hot, install the steam nozzle in a position which will NOT easily come into contact with the steam room user, as contact could result in the user sustaining burns.*

1. Install the steam nozzle at a height of 150mm – 300mm above the finished floor level.
2. The steam nozzle outlet should be installed face down.

 **Attention:** *In order to protect the steam nozzle, do not use a spanner or other tools to tighten it, use a little soap water and soft sponge to wipe, and do not use erosive chemical solutions or abrasive cleaning materials*

**Important:**

1. Please consult your distributors of building materials like acrylic, fiber glass or other anti-heat sheet, about the installation position of steam nozzle.
2. For the optimal performance of the steam generator, it is recommended that the steam room be well sealed to prevent any steam from escaping.

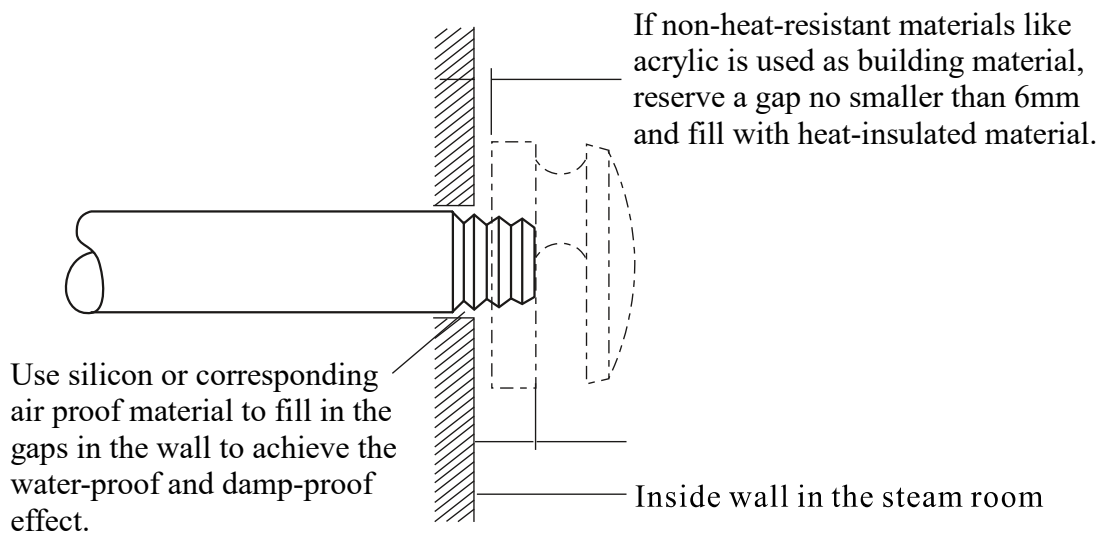

### Drainpipe

According to national or local rules, the steam engine drainage valve should be equipped with a drainpipe. The steam engine drains the water using gravity.

**Attention:** *the drainpipe should not incline upwards so as to facilitate the drainage of water.*

### Safety valve

1. The safety valve is a piece of safety equipment used to prevent too much steam pressure in the interior steam engine due to various reasons.
2. The pressure limit range of the safety valve is 15PSI and the pressure will begin to decrease if pressure should surpass this value.

**Attention:**

1. Do not dismantle the pressure decrease safety valve. If necessary, this should be done by qualified personnel only.
2. To maintain the proper and automatic operation of safety valve, make sure the safety valve is not obstructed in any way.

**Blueprint for the steam generator**

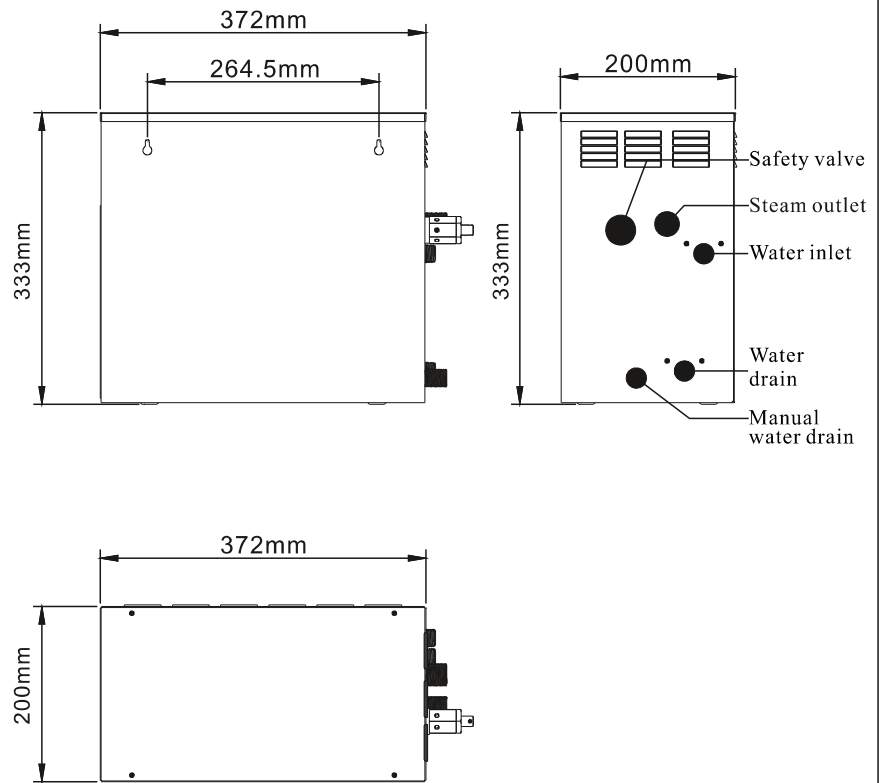
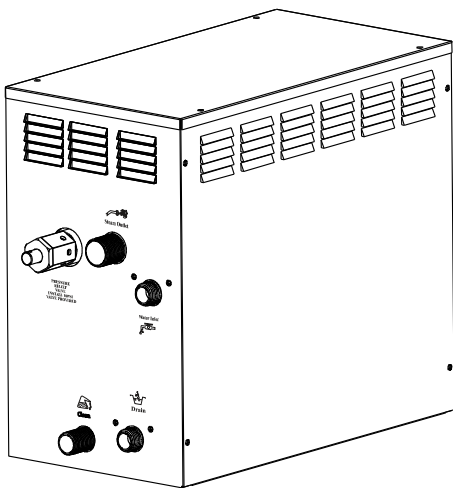

9KW

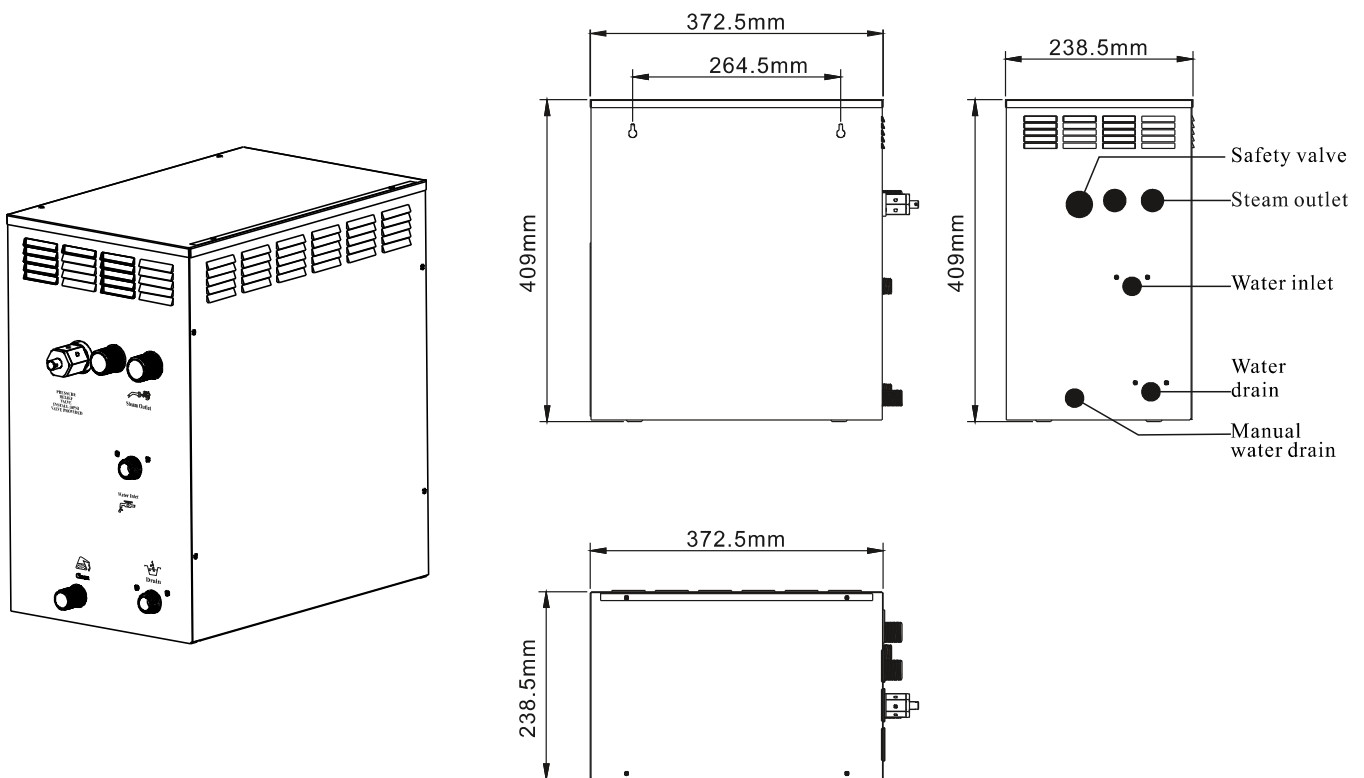

18KW



**Attention:** To facilitate maintenance, keep the steam generator clean.

### Electrical requirements:



**Caution:** Only qualified personnel to connect electrical supply.

### Electricity supply circuitry:

1. Test the voltage of electricity supply and make sure that the steam generator is suitable.
2. Insulated copper wire should be used with an anti-heat temperature of 90°C and a specified voltage of 500V. Refer to national or local electricity consumption code for the specifications. Refer to the ammeter for the ampere on page 21.
3. Install an independent circuit breaker & isolator between the power supply and the steam engine so as to provide an electricity supply with overflow protection and electricity leakage protection



**Attention:** All the connections must be in accordance with the national and local electricity consumption code and be installed by professional electricians or qualified personnel



## Installation of the top light

Light is available in a 220V output. Before connecting to the light, please consult with the light manufacturer to confirm the voltage of the light, so as to avoid any damage to the steam generator or any cause of danger.

As the light input is 220v~240V, light power should not be more than 100W.

The light should be installed in the ceiling of the steam room or in a suitable place that is not accessible to children.

**CAUTION:** *Make sure that appropriate lighting is used so as to prevent electrical components from being exposed to moisture as it can cause damage or short circuit.*

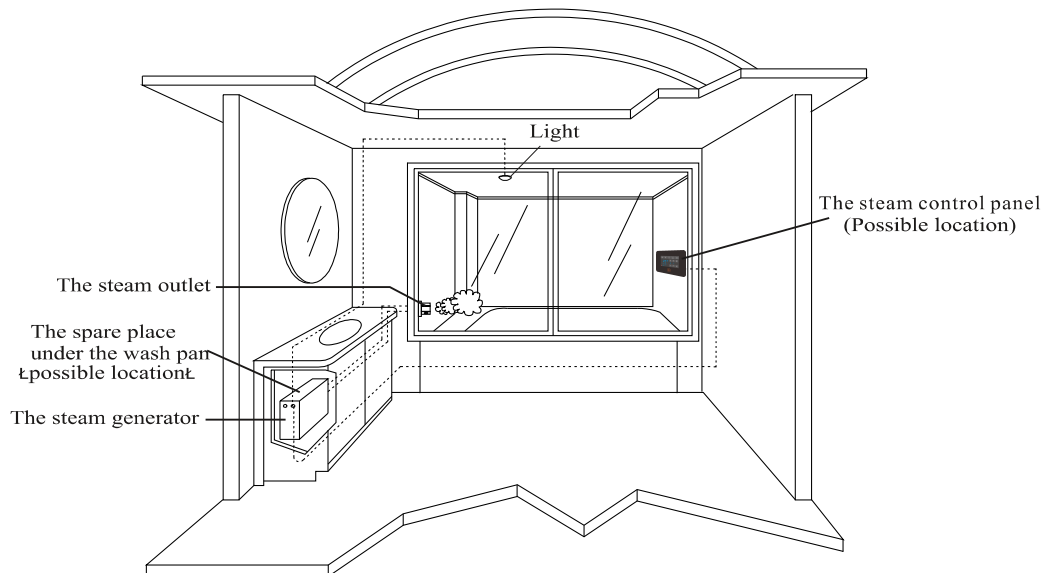

**CAUTION:** *The illustration is for explanation purposes, the practical installation must comply with national building and electrical regulations.*

### Choose your type of machine

Example: L:2.5M x W: 1.5M x H:2M = 7.5 M<sup>3</sup>  
 You would need the 9KW Model (it is that simple)

However, if your shower materials are:

A:Natural Stone(Granite or Marble etc.)	ADD	75%
B:Exterior walls	ADD	25%
C:Celia Heights exceeding 2.4M	ADD	25%
D:Ceramic tile	ADD	75%
E:Glass(2 walls)	ADD	75%

 **Important:** *The calculation formula for selecting the type of steam generator is for reference only. Due to the variability of the building, the specifications and size illustration are used as guidelines only.*

### Maintenance of the steam engine

 **Important:** *Perform water discharge operation after each use.*

1. Wait for the completion of automatic water discharge after each use of the steam generator to make sure the water in the tank is discharged completely before cutting off power supply.
2. There should not be any leakage or damage among the steam generator, steam nozzle, components and pipes. They should be checked annually and if necessary repaired.
3. Clean the water supply pipes of the steam engine once a year.
4. Check all the connections, faucets and connection terminals to see whether they have become loose or are damaged due to overheat.
5. Check the furring (Scale) accumulated in the water tank and electric heating tube. If the Furring (Scale) is thick, dispose of it in time (use diluted lemon acid to soak for 15-30 minutes).
6. Remove the water level sensory needle once a quarter to clean the furring (Scale) from the needle.

## Configuration of steam generator

9KW

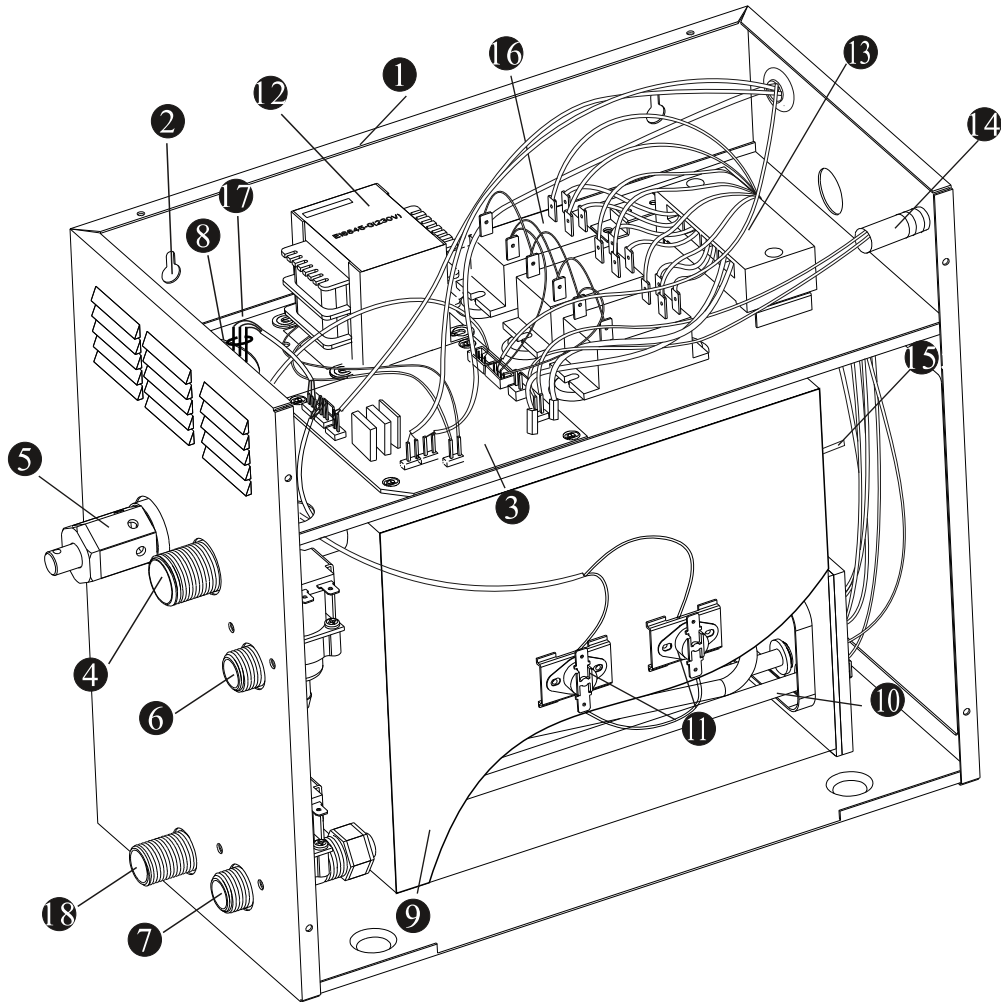

- |                         |                         |                        |
|-------------------------|-------------------------|------------------------|
| ① Enclosure             | ⑦ Water drain valve     | ⑬ Terminal block       |
| ② Installation bracket  | ⑧ Subsidiary water tank | ⑭ Fuse                 |
| ③ Circuit board         | ⑨ Main water tank       | ⑮ Earth wire connector |
| ④ Steam Outlet          | ⑩ Heating Element       | ⑯ Relay                |
| ⑤ Pressure relief valve | ⑪ 105°C Hi-limit        | ⑰ Water level sensor   |
| ⑥ Water fill valve      | ⑫ Transformer           | ⑱ Manual water drain   |

**Control Panel Layout and Interface**

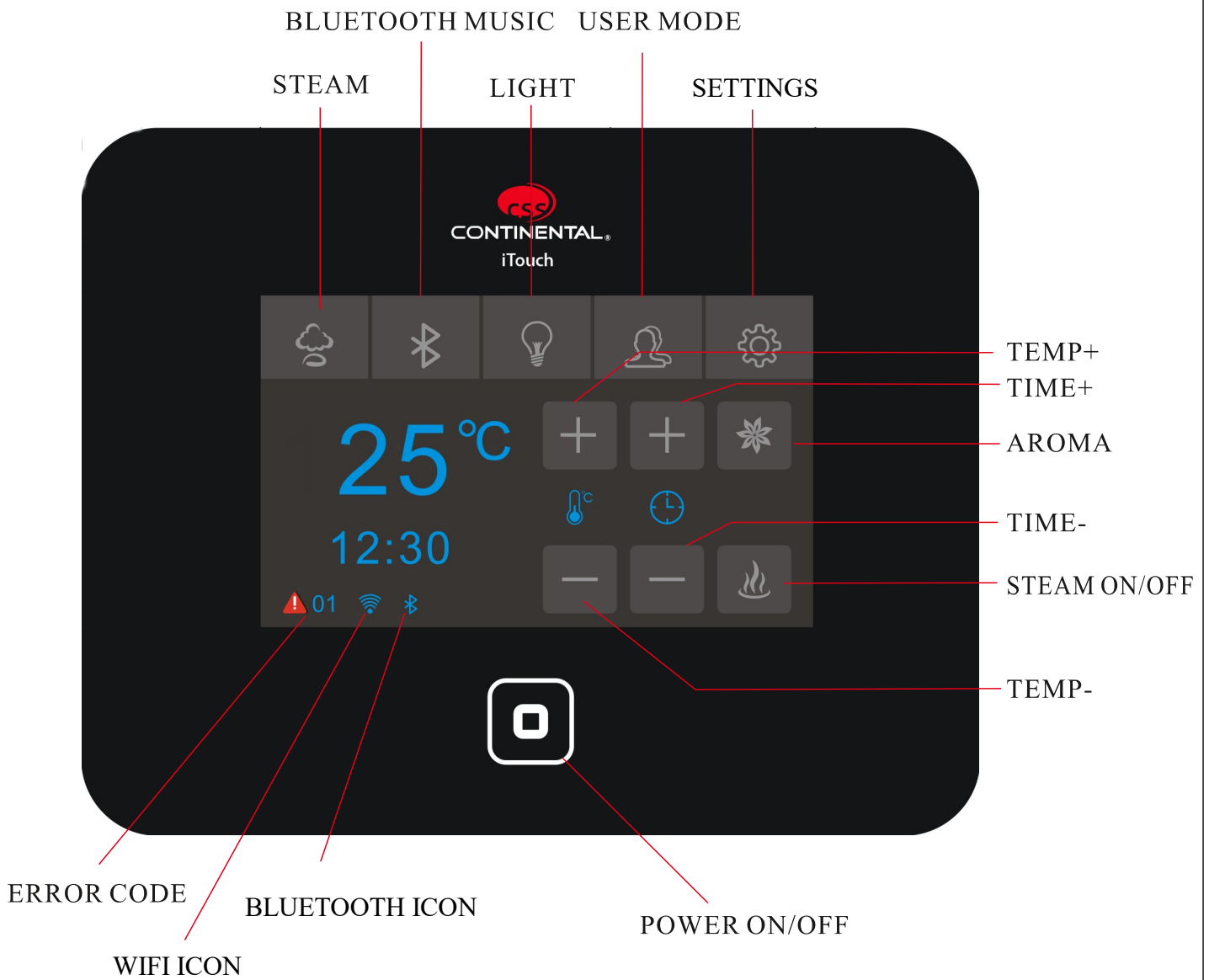

**Control Panel Installation Options**

**Important:**

- *If the control panel is installed inside the steam room, it must be at a height of 1.8M from FFL.*
- *If the control panel is installed outside the steam room, then the control panel can be installed at switch height, but the temperature sensor must be installed at 1.8m from FFL inside the steam room.*

**A. Recess mount into wall with wall mount box**

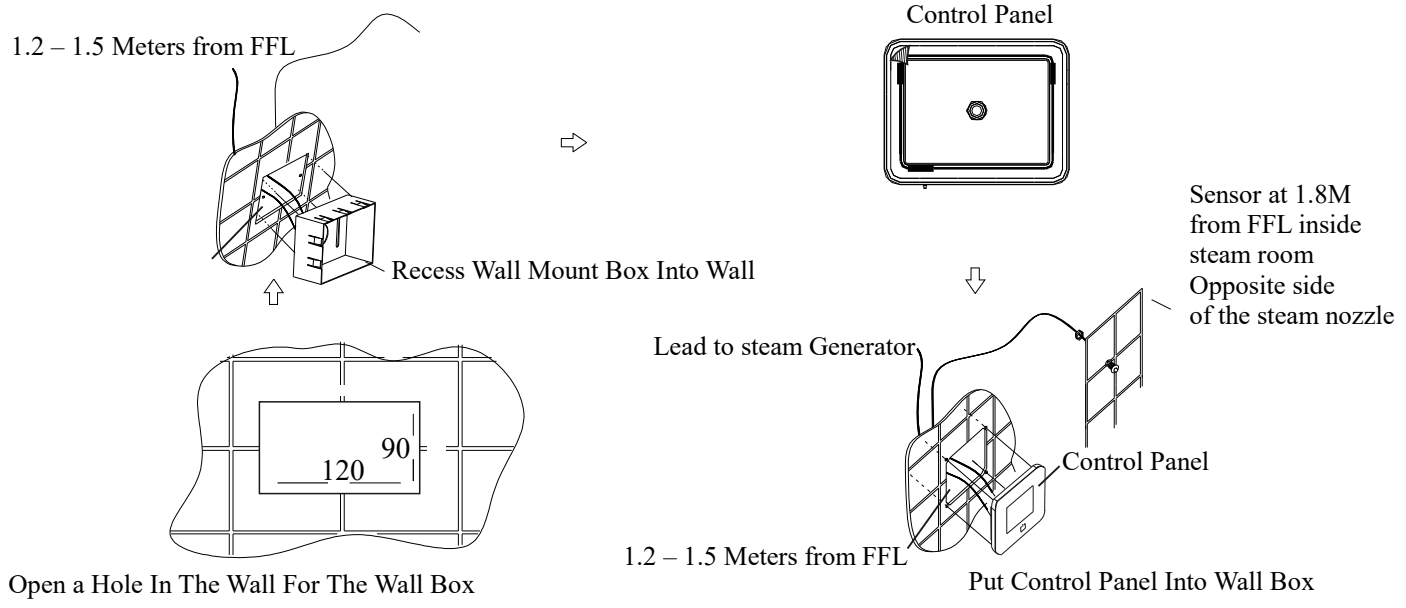

**B. Mount without wall box**

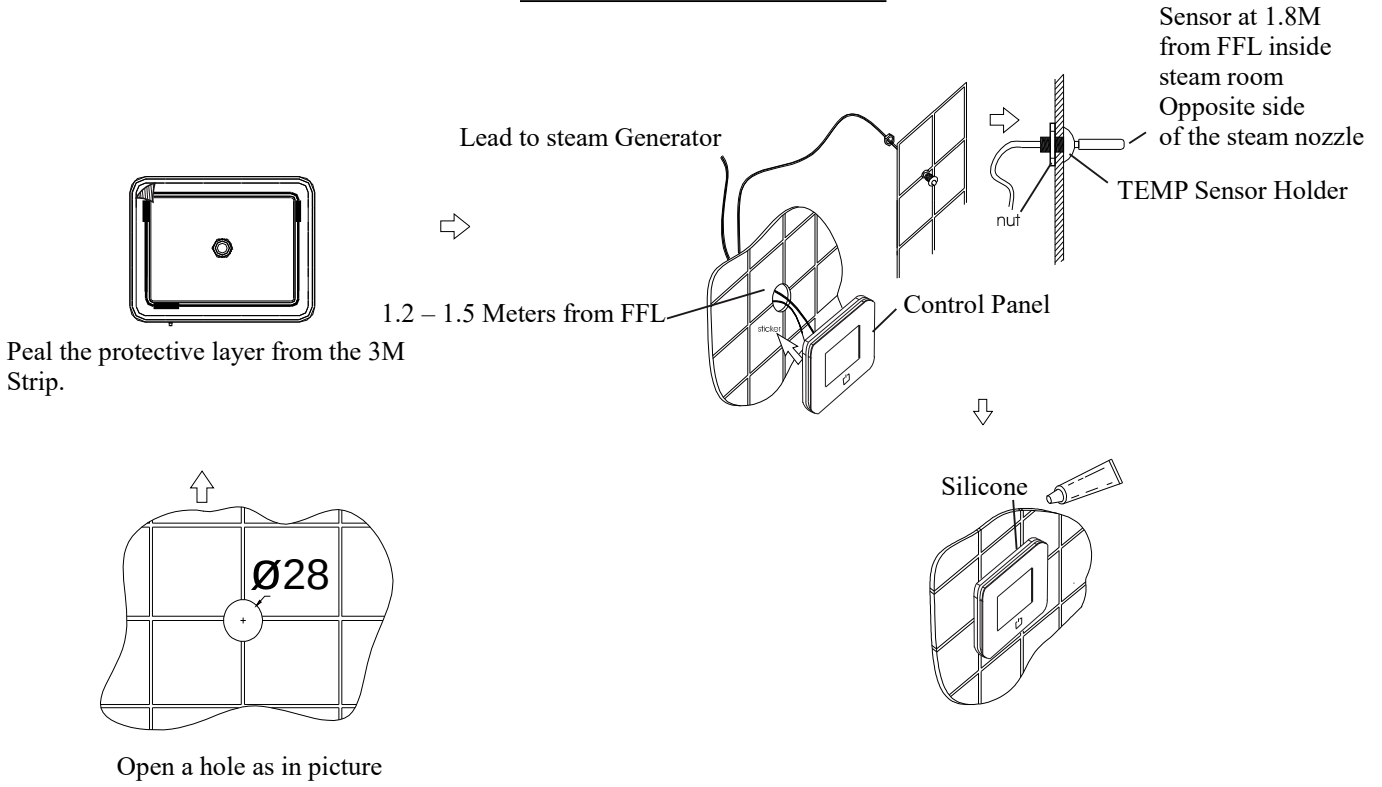

**Control Panel Dimensions**

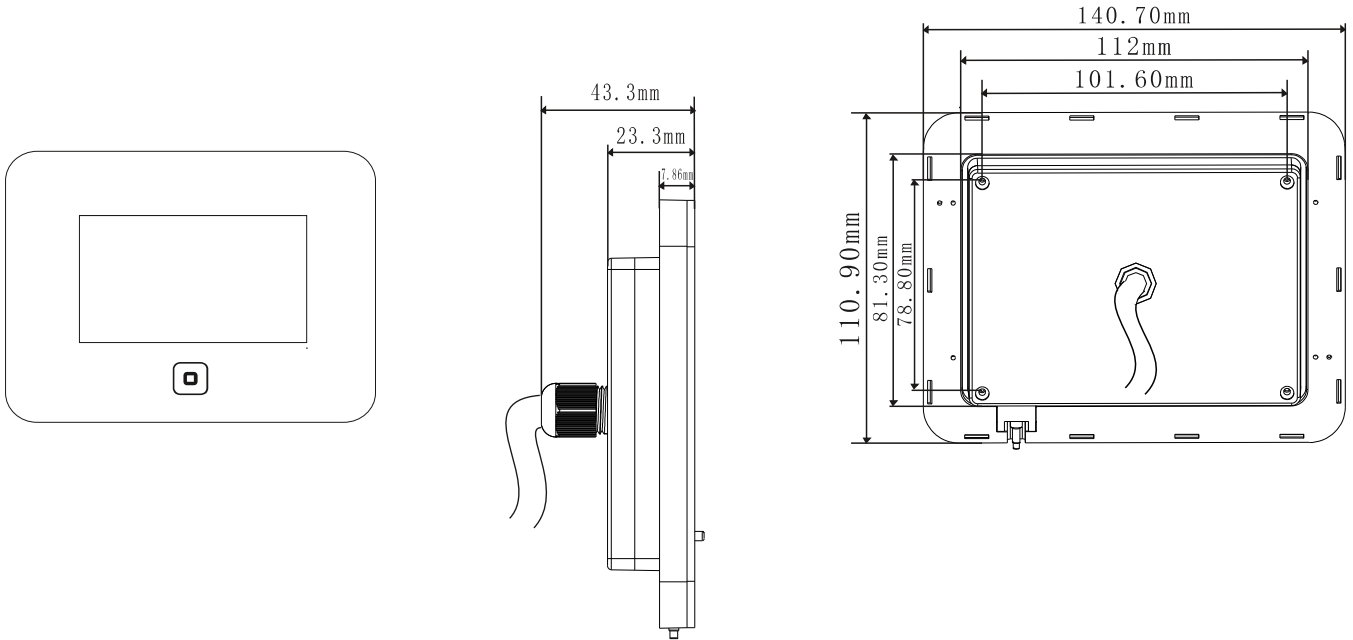

**Without Expansion Bracket**

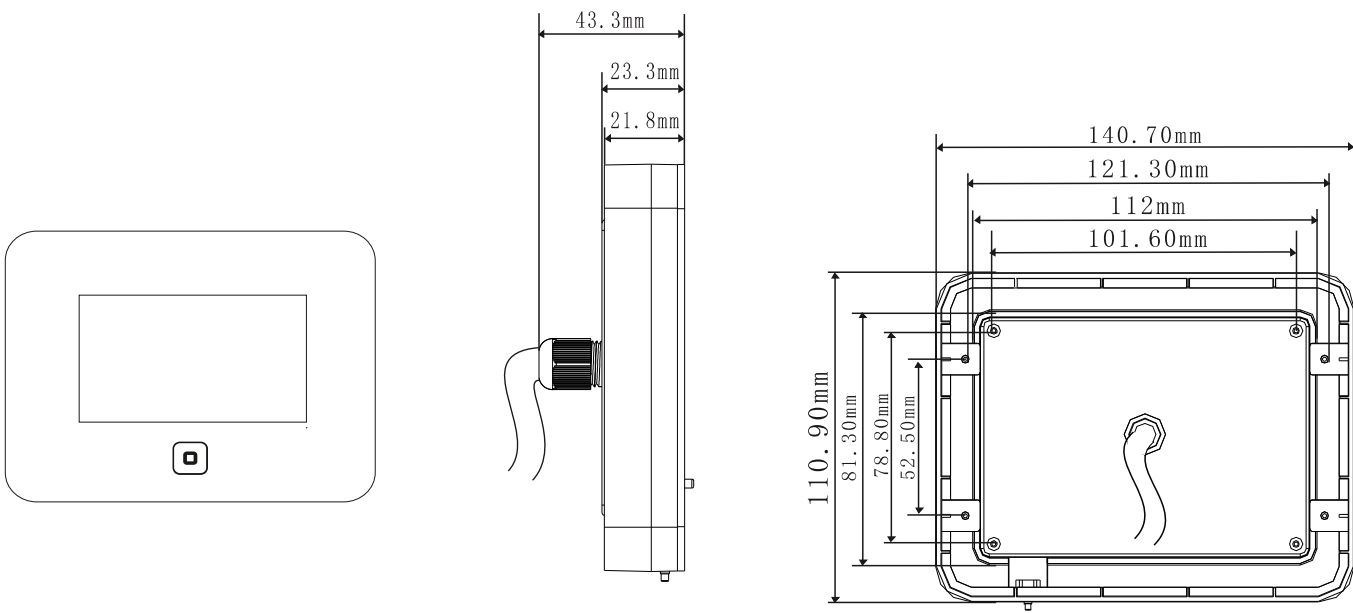

**With Expansion Bracket**

## Operation Instructions

### 1. Power On

- When the system is electrified, you will hear a “BEEP” sound from the control panel.
- The steam generator is now in standby mode as per image below.
- Time will only display in standby mode once the clock has been set. Otherwise only a blank screen will be displayed.



- From the standby mode, touch the  button to switch on the system. The screen will display the current temperature inside the steam room as per the picture below.
- This is the home screen.
- If the system has been set to switch on via the timing function, then the system will switch on automatically and start the steam function at the preset time.





### Power Off

- When the system is in working mode, touch the  button to switch off the system. The screen will display the real-time clock if preset, otherwise only a blank screen will display.
- When the system reaches the power-off setting time, the system will power off automatically.



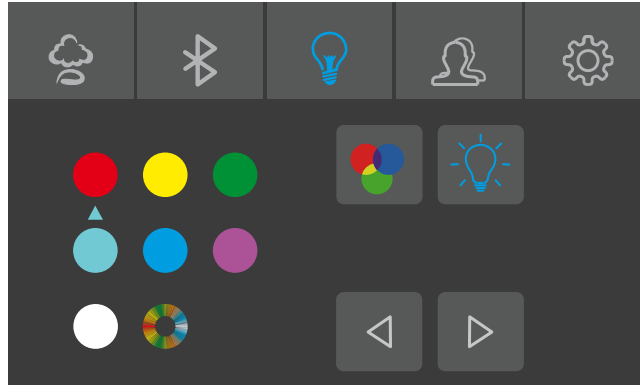

### 3. Light Power On

- When the system is in working mode, press the  button to enter the light interface as displayed below.







- Press the button  to power on the light.
- Press the button  to power off the light.

### Chroma Light Power On

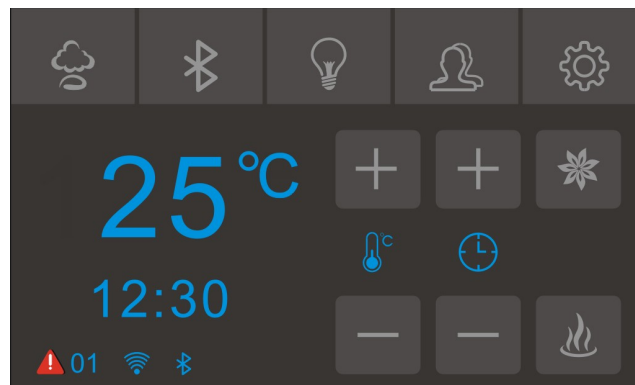
- From the light interface as displayed above, press the  button to power on the chroma light.
- Now press the   button to change colors.
- Press the  button to switch off the chroma light.



### 3. Steam Function





- The above interface is the default interface displayed when the system activated from standby mode
- Enter the interface above from any other interface by pressing by pressing the  button.
- From the interface as displayed above, press the  button to start the steam function.
- Press the  button to switch off the steam function.





### Temperature setting:

- When the steam function is active, press button  and  with the  symbol between them, to set steam temperature,
- TEMP range is 25-68°C and increases or decreases in increments of 1°C.



### Steam Run Time setting:

- When the steam function is active, press the button  and  with the  symbol between them, to set steam run time.
- Time range is from 30mins to 20 hours in increments of 30 minutes.



### Aroma: Enables the aroma dispenser (Optional Extra)

- When the steam function is active, press the button  to switch on aroma function, press the  button again to switch off aroma function. The aroma function will automatically stop working when the steam function is stopped.

### User Mode: Enables you to save a preset working time and temperature for up to 5 users.



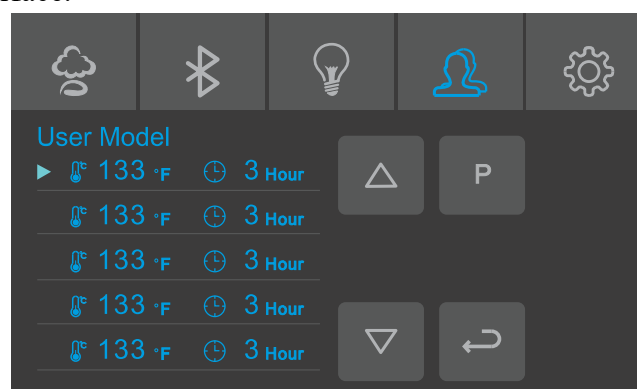

- Begin by selecting your preferred temperature and run time from the steam interface accessible by pressing the  button.
- Enter the user mode by pressing the  button.

### To Save a user mode:

- When system is in user mode interface as per picture below, press button  and  to choose the user mode column, press button  to save the temperature and time you set earlier on the steam function interface.





### To Activate a user mode:

- Press the  and  buttons to select the user mode you set, press the button  to start the steam function under the temperature and time you set.
- Now enter the steam interface by pressing the  button
- Now turn on the steam function from the steam interface by pressing the  button.
- The steam generator will now operate for the preset time and at the preset temperature.

### Auto On Timer Function:

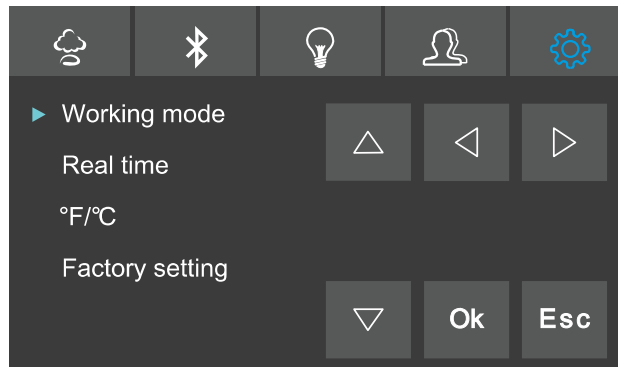

- Enter the settings interface below by pressing the  button.



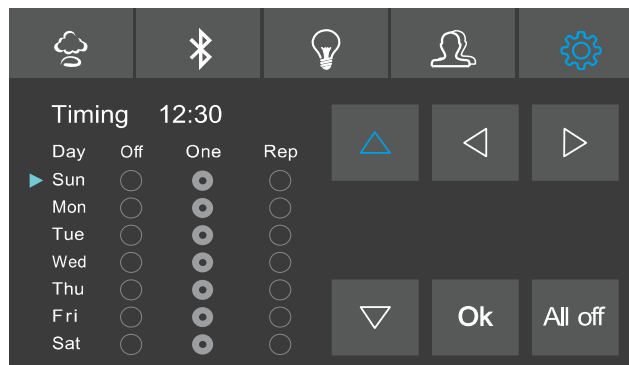





- When system is in setting interface as in image above, select "work mode" column, press  to enter the interface as displayed below.



### Time Setting



- Move the arrow to the "Timing" column, now press the  button to set hour and press the button  to set minutes.
- Hour range is from 0-23 hours with one hour increments.
- Minute range is from 0-50 with 10 minute increments.

### Working Mode



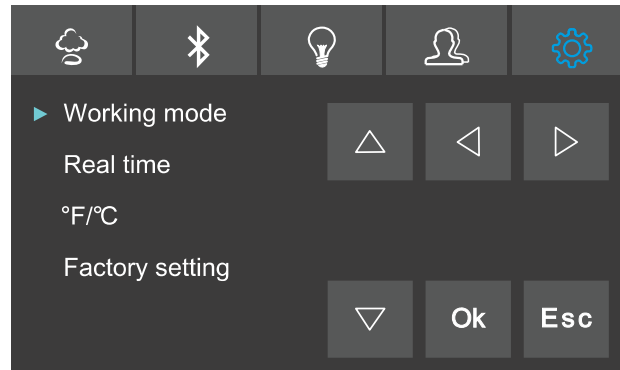



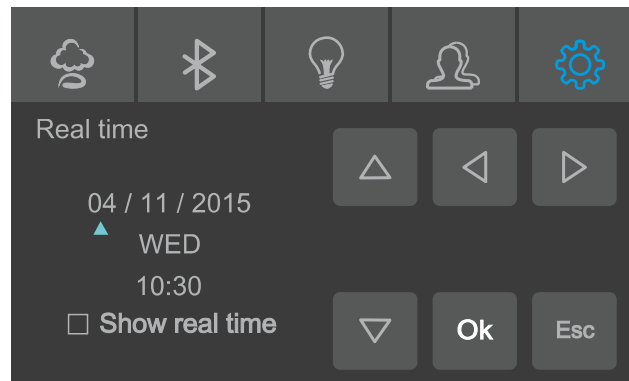

- Press the  and  buttons to move arrow from Sunday to Monday, press the  and  button to select steam option.
- You can select **One time**, **Repeat** or **Off**. The repeat function works based on the set day and time. For example...
- Selecting Repeat means the steam generator will repeat the preset order at the same time and day as preset every week. Example every Wednesday at 17:00 the steam generator will turn on.
- Selecting One, means the steam generator will work once as per the preset order and will not repeat.
- Press the  button to save the working mode you have set. Press  button to exit this operation interface.

## Real clock



- When the system is in the settings interface as in image above, Select the “Real Time” column by pressing the  button.
- Press the  button to enter the interface in the image below.







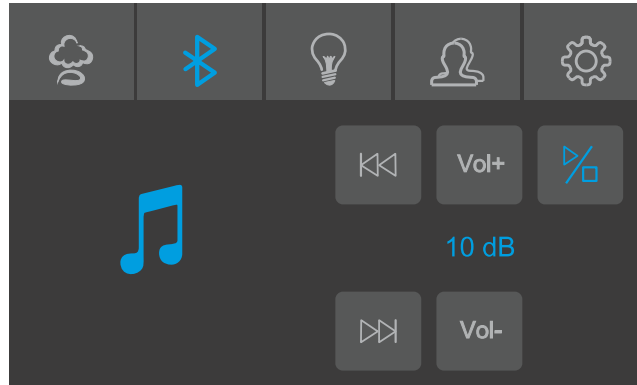

- Press button  and  to move arrow to the data you like to set, such as hour, minute, date, month, year and show real time or not after system power off.
- Press the  and  buttons to adjust data. Timer parameters will be calculated via the date entered here.
- When complete, press  to save the set parameters, press  to exit settings.
- Pressing the  Button before the  button, means your settings won't be saved.

**Bluetooth Music:**

- Open Bluetooth on your mobile device select the “SANJUN-MUSIC” Bluetooth device.
- Enter password “0000” to complete the pairing process. Select “SANJUN-MUSIC” as your audio output on your mobile device.
- Open you playlist



- Select the Bluetooth interface as show in image above by pressing the  button .
- 
- Press  to play music.
- Press  to stop music.
- Press   to increase or decrease volume.
- Press   to select next or previous song.

## Trouble Shooting

Error code	Fault description	Trouble shooting
03	Hi-limit	Please check whether there is excessive fur (scale) inside water tank.
05	Water inlet problem	Please check water supply or the water inlet valve.
08	Temperature sensor	Please check the temperature sensor cable, if not good, please kindly change the temperature sensor
09	Temperature sensor	Please check the temperature sensor cable, if not good, please kindly change the temperature sensor.

## TECHNICAL PARAMETERS

Working conditions and characteristics			
Rated voltage	AC220V	Rated frequency	50Hz
Rated voltage		Rated power	
Insulation resistance		Waterproof level	
Load the configuration parameters			
Loading	Load Voltage	Load Frequency	Load Power
Music box	AC220V	50Hz	10W
Light	AC220V		< 100W
Chroma Light	DC12V		<20W
Solenoid Valve	DC12V		5W * 2

## Trouble Shooting Methods

To facilitate your use and maintenance of steam room, the following common trouble shooting methods are listed for identification.

Trouble	Possible Causes of trouble	Trouble-shooting methods
<b>The machine does not start when electrified</b>	<ol style="list-style-type: none"> <li>1.The fuse is burned.</li> <li>2.The wire connection terminal has become loose.</li> <li>3. Contact in the connection wire between the controller and the steam generator is not good.</li> </ol>	<ol style="list-style-type: none"> <li>1.Too much pressure inside the steam engine, so the system breaks for heat protection.</li> <li>2.Wire is broken for heat protection.</li> </ol>
<b>Electricity leakage switch breaks automatically</b>	<ol style="list-style-type: none"> <li>1.The wire connector is dampened or damaged.</li> <li>2.The heating element is faulty</li> </ol>	<ol style="list-style-type: none"> <li>1.Check whether the wire connector is dampened or damaged, and dry with dryer if dampened.</li> <li>2. Change a heating element.</li> </ol>
<b>When the machine is Switched on, hot water comes out with little or no steam</b>	<ol style="list-style-type: none"> <li>1. The water drainage valve is broken.</li> </ol>	<ol style="list-style-type: none"> <li>1. Change a water drainage valve.</li> </ol>
<b>The display screen on the control panel does not display</b>	<ol style="list-style-type: none"> <li>1.The power wire is not connected well or not in good contact. The connection plug between the control panel and the electrically-controlled box is loose.</li> <li>2.Trouble with plug board.</li> </ol>	<ol style="list-style-type: none"> <li>1.Check whether the connection plug between the control panel and the electrically controlled box has become loose, and whether the power circuitry has good contact.</li> </ol>
<b>Water leakage</b>	<ol style="list-style-type: none"> <li>1.The water pipe connector is loose or the pipe has burst.</li> <li>2.Water leakage in the water input valve or the water drainage valve</li> </ol>	<ol style="list-style-type: none"> <li>1.Tighten the loose connector, and change the broken pipe.</li> <li>2.Change the water input valve or the water drainage valve.</li> <li>3.Change water pipe.</li> </ol>
<b>No steam when starting the machine</b>	<ol style="list-style-type: none"> <li>1.No electricity.</li> <li>2.No water.</li> <li>3.The set temperature is too low</li> <li>4.Trouble with wire.</li> </ol>	<ol style="list-style-type: none"> <li>1.Check the power supply</li> <li>2.Check the water input pipe and water input valve</li> <li>3.Reset the temperature</li> <li>4.Contact the distributor</li> </ol>
<b>The steam does not come out, the water sounds in the machine</b>	<ol style="list-style-type: none"> <li>1. The steam pipe is jammed.</li> </ol>	<ol style="list-style-type: none"> <li>1. Cut power supply &amp; check whether the steam pipe is clear.</li> </ol>
<b>The light can not be turned on</b>	<ol style="list-style-type: none"> <li>1. The fuse is burned.</li> <li>2. The light is broken</li> <li>3. The wire is broken</li> <li>4. The plug does not have good contact</li> </ol>	<ol style="list-style-type: none"> <li>1. Change the fuse (on the shell 1A/250V)</li> <li>2. Change a light bulb.</li> <li>3. Change wire.</li> <li>4. Make sure wire contact is good.</li> </ol>
<b>The display box displays normally with no steam input</b>	<ol style="list-style-type: none"> <li>1.Too much pressure inside the steam engine, so the system breaks for heat protection.</li> <li>2.Wire is broken for heat protection.</li> </ol>	<ol style="list-style-type: none"> <li>1.Check the steam transport pipe. System will restore automatically after tank becomes cool.</li> <li>2.Check the heat protection wire to make sure the connection is good.</li> </ol>

### Ampere Meter

Type	Applicable space of the room (m3)	Electricity supply	Max . Electric current (A)	Specifications for power wire
<b>GS08M-9kW</b>	10-12	380V~ 3PH 220V~(1PH/2PH)	13.7A 40A	6mm <sup>2</sup> 4mm <sup>2</sup>
<b>GS08M-18kW</b>	20-24	380V~ 3PH	27.3A	6mm <sup>2</sup>

The data provided above are for 220V(1PH) and 380V(3PH).

Within eye-shot of the steam engine, install an independent circuit breaker & Isolator so as to provide an electricity supply with overflow protection and electricity leakage protection.

## Technical parameter

### TYPE GS08M

Power Output	9KW	18KW
Potency Error	±10%	±10%
Duration	>1500V	>1500V
Resistance	>20MΩ	>20MΩ
Steam Pressure	0.14MPa	0.16MPa
Steam Volume ml/min	260	500
Steam Production Time s	130 - 190	130 - 190
Water Tank Volume	3.5L	7.5L
Applicable space of the room(m <sup>3</sup> )	10~12	20~24



**Important:** *The parameter listed in the table will vary in different geographic locations and temperatures, please consult a qualified designer and architect in your location.*



**Figure(Heating element and Power line assembly illustration)**

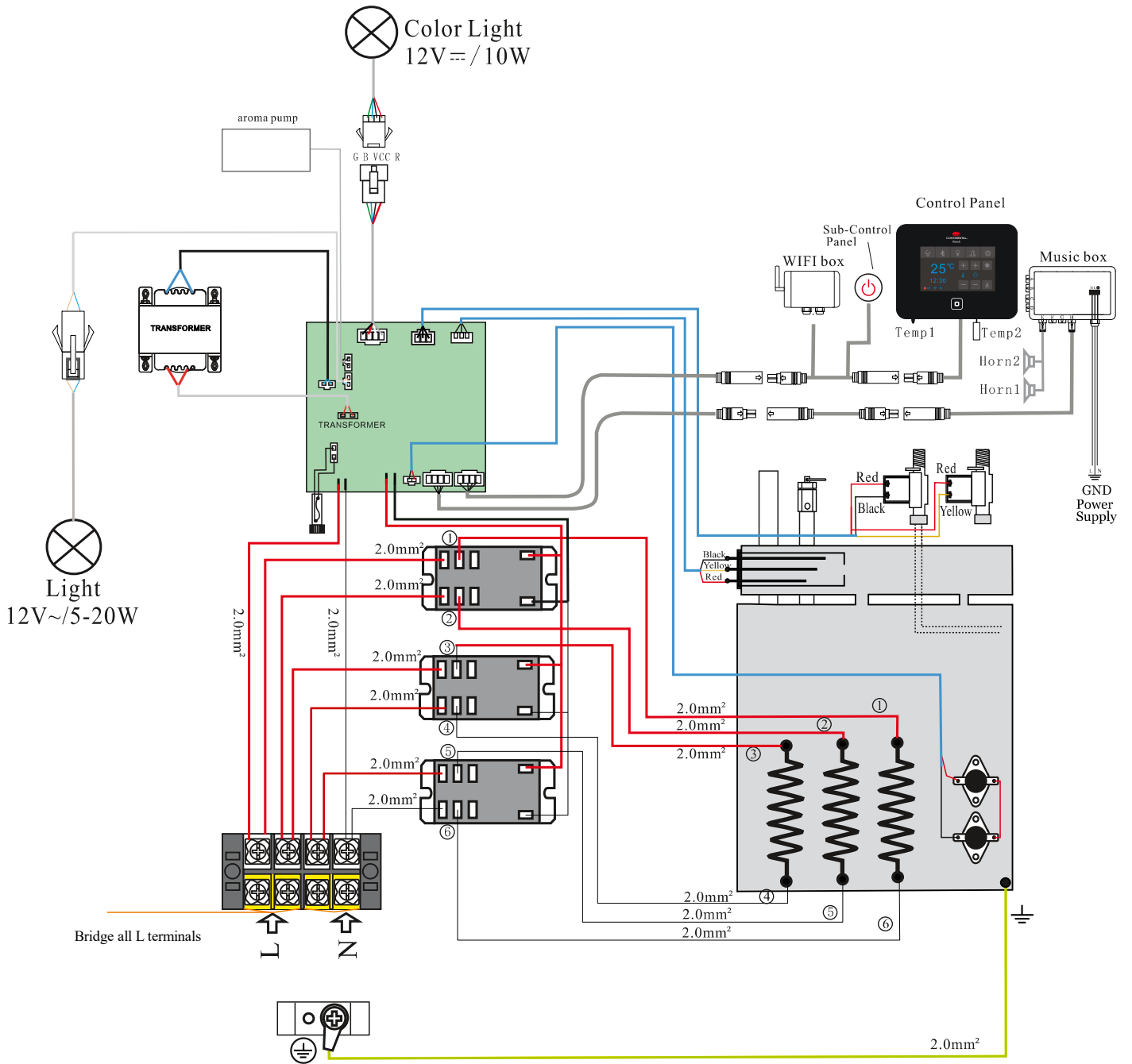

Internal wiring diagram of steam generator  
9kw(220-240V/1phase)

**Figure(Heating element and Power line assembly illustration)**

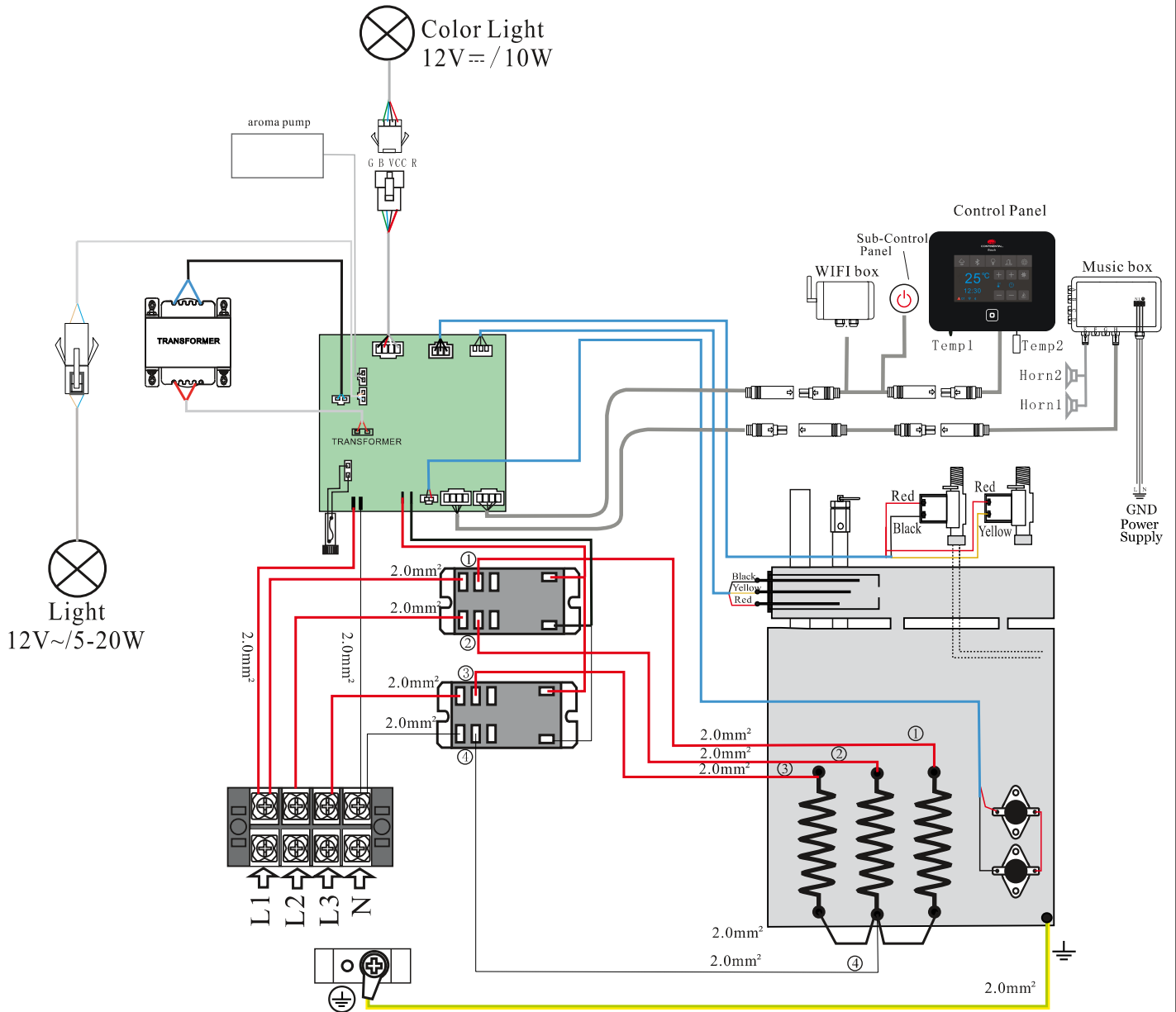

Internal wiring diagram of steam generator  
9kw (380-415V/3phase)

**Figure(Heating element and Power line assembly illustration)**

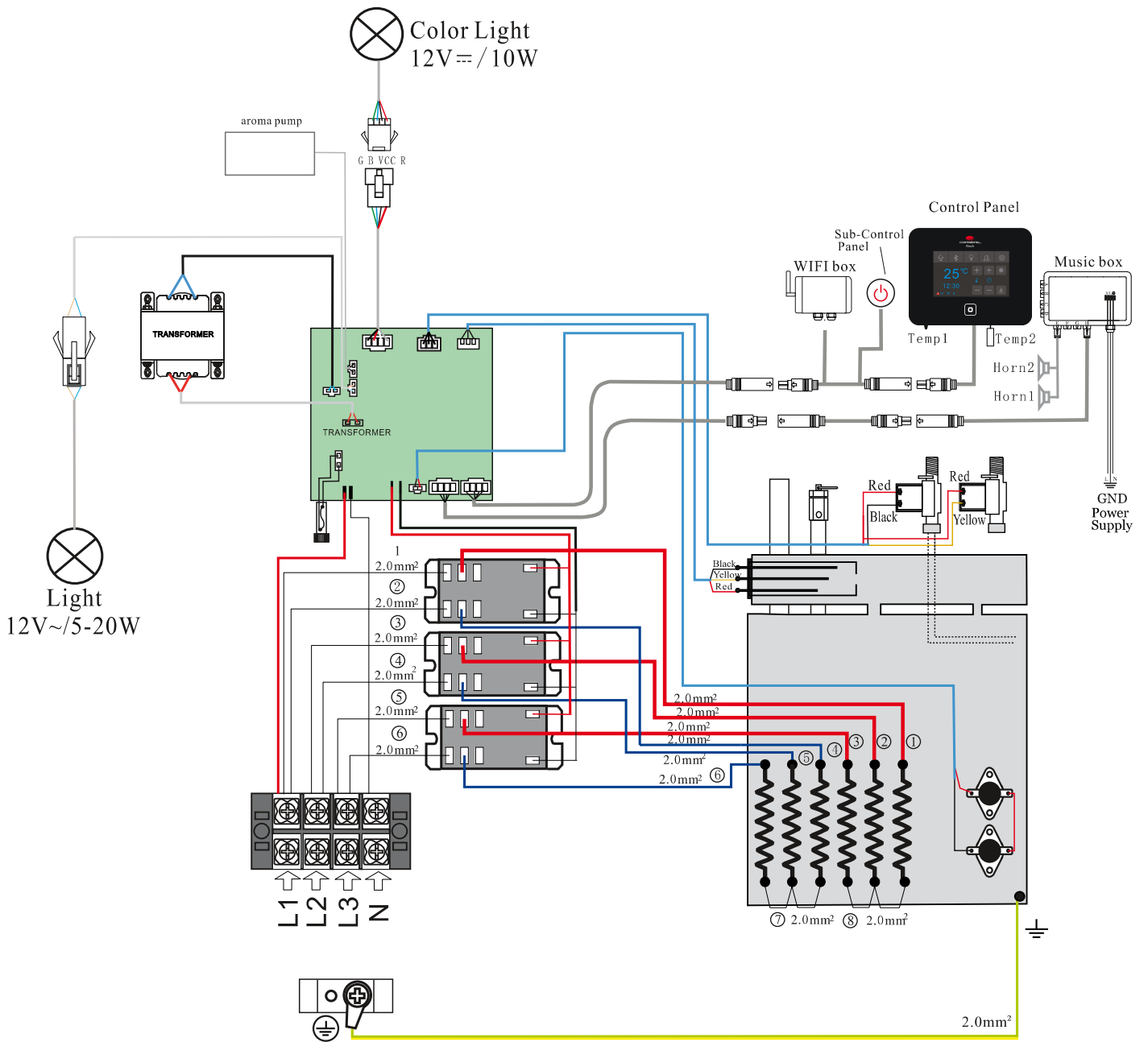

Internal wiring diagram of steam generator  
18kw (380-415V/3phase)

Continental Frameless Glass, Steam, Sauna & Spa (Pty) Ltd  
411 Martin Crescent, Greenhills Industrial Estate,  
Germiston, Gauteng, South Africa, 1416

Tel:+27 822 7170 | Web: [www.continentalsa.co](http://www.continentalsa.co) | Email: [Sales@continentalsa.co](mailto:Sales@continentalsa.co)